

Инструкция по сборке типовая

Хейсон - 18

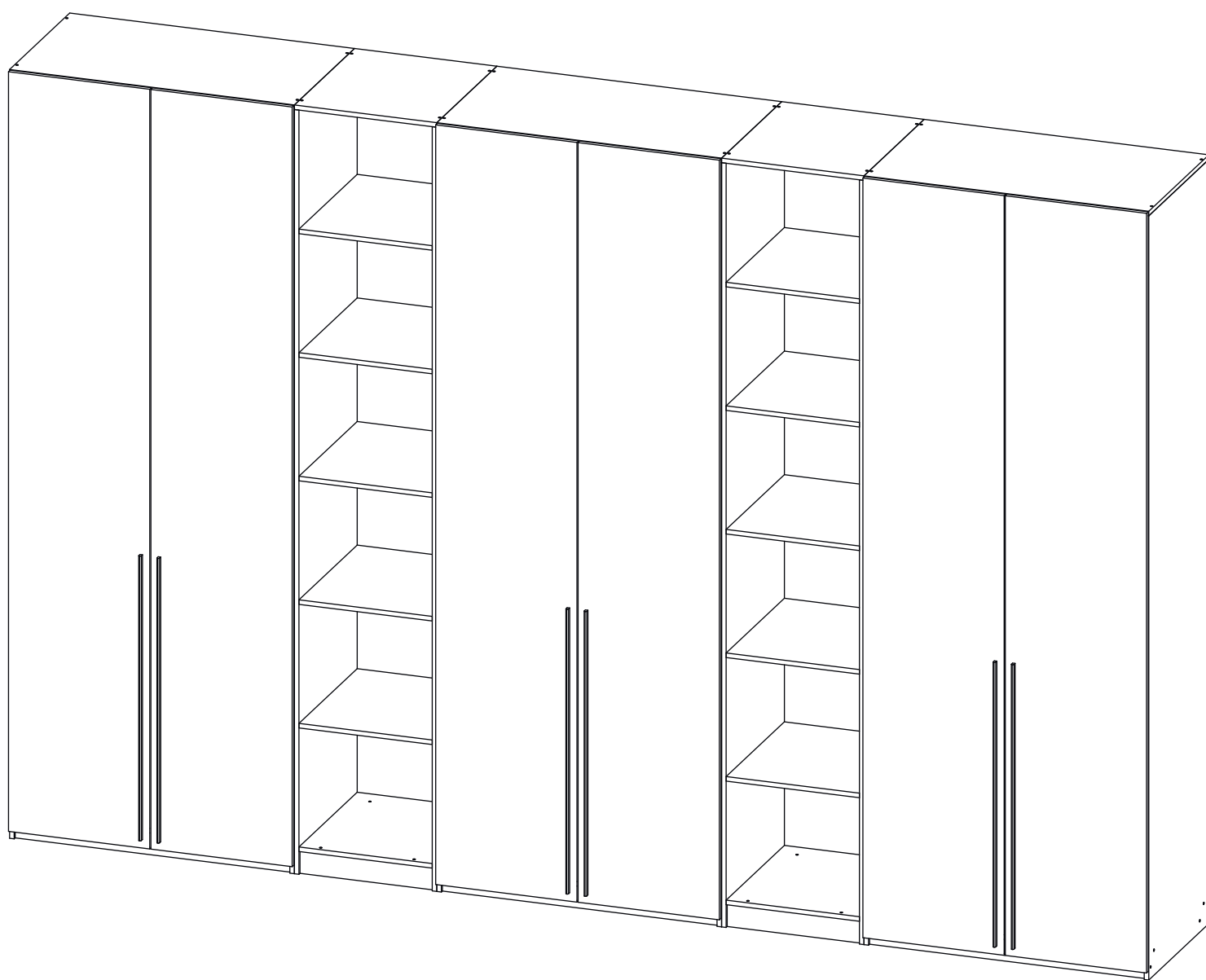

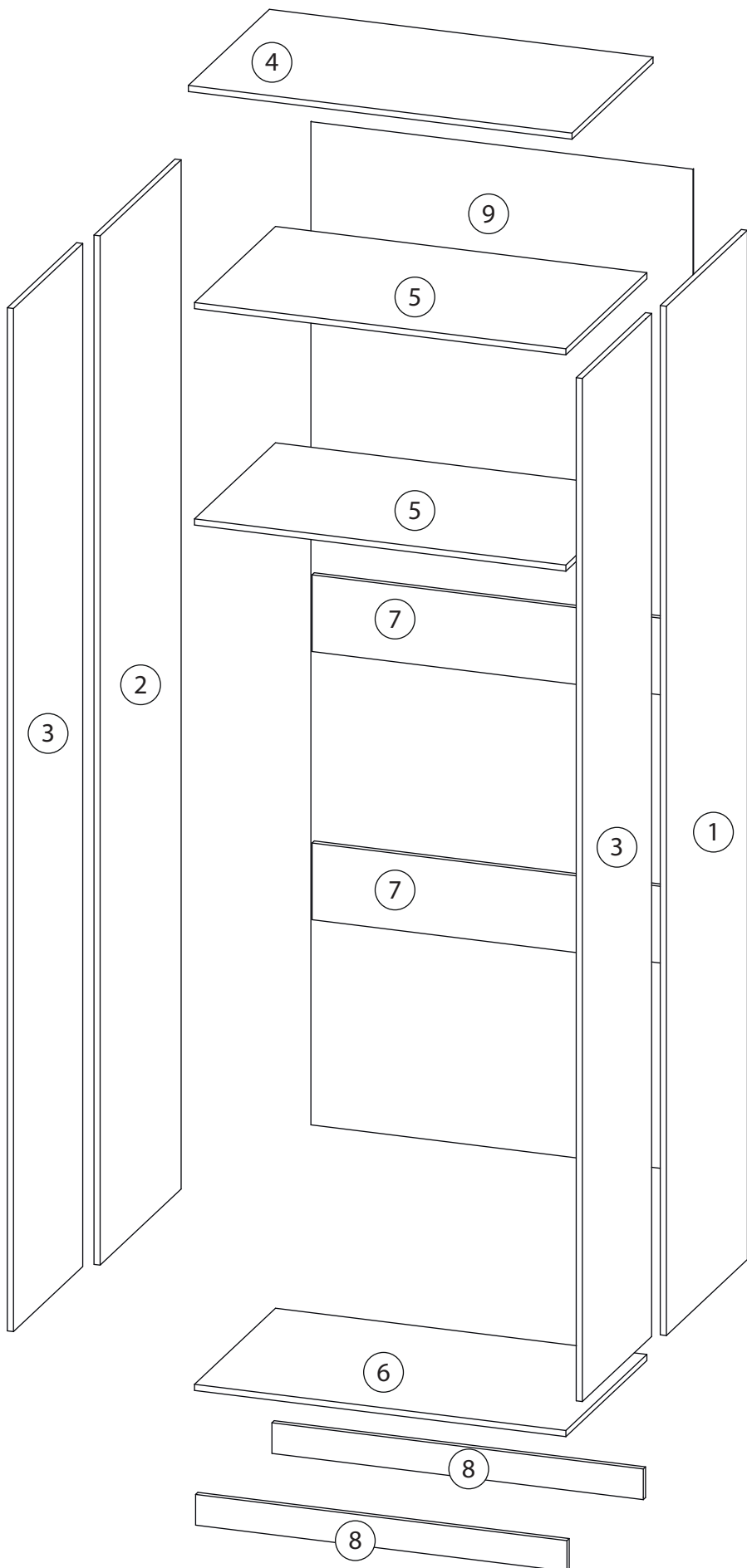





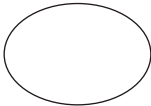
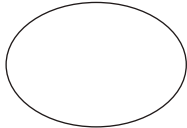

Детали

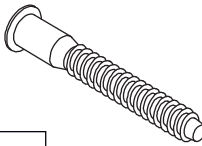
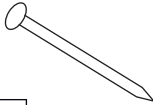

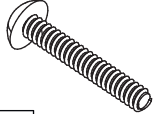
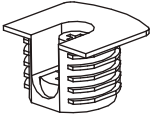
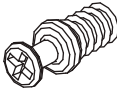
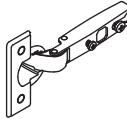
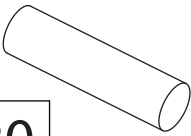
Поз.	Наименование	Кол-во
1	Бок правый	1
2	Бок левый	1
3	Фасад	1
4	Крыша	1
5	Полка	2
6	Дно	1
7	Ребро жесткости	1
8	Цоколь	2
9	з/с	1

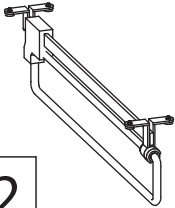
Фурнитура

				
10	11	12	13	14
<u>Заглушка</u> Ø13	<u>Заглушка</u> Ø17-20	<u>Ручка</u>	<u>Евровинт 7x50</u>	<u>Гвоздь 1,6x25</u>
				
15	16	17	18	19
<u>Саморез 3,5x16</u>	<u>Винт для ручки</u> M4x23	<u>Стяжка VB35</u>	<u>Винт для стяжки</u> VB35	<u>Петля накладная</u>
				
20	21	22	23	
<u>Штанга</u>	<u>Штангодержатель</u>	<u>Штанга</u> <u>выдвижная</u>	<u>Евровинт 6,3x13</u>	

При глубине меньше 500мм устанавливается выдвижная штанга.

1

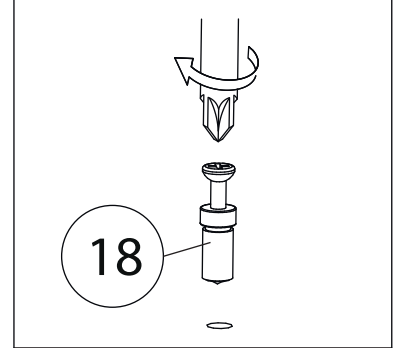
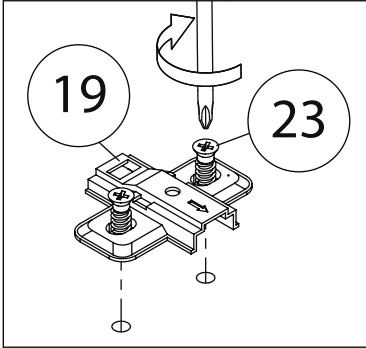
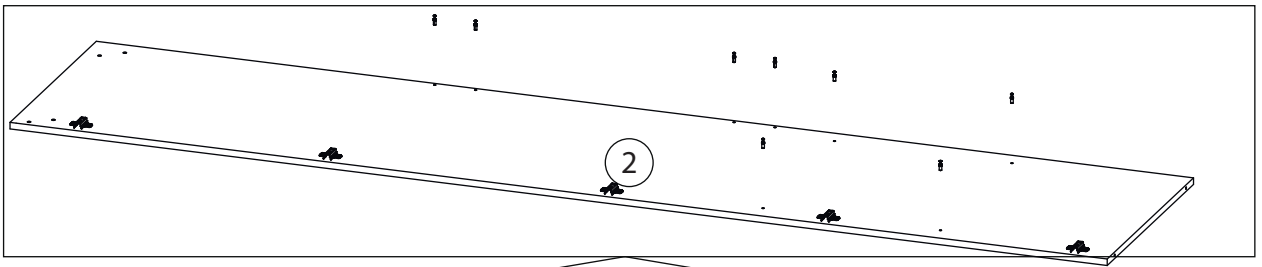

2

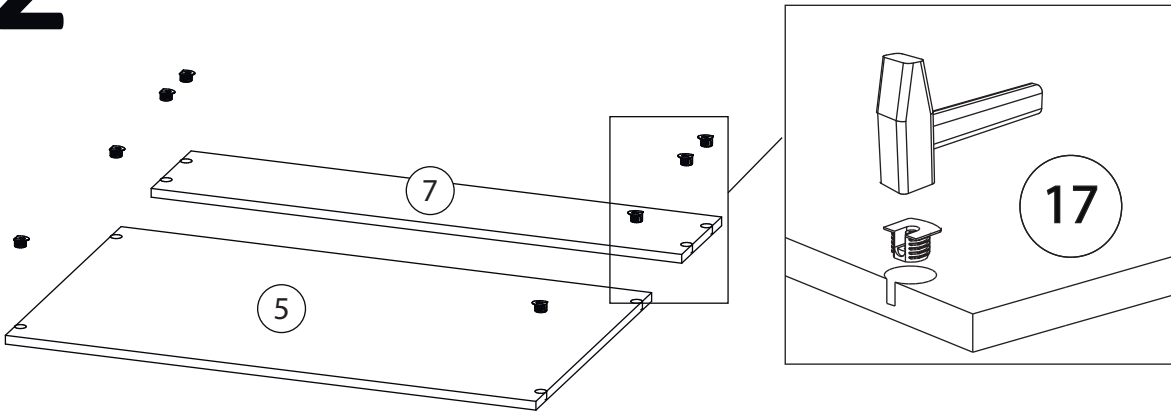

3

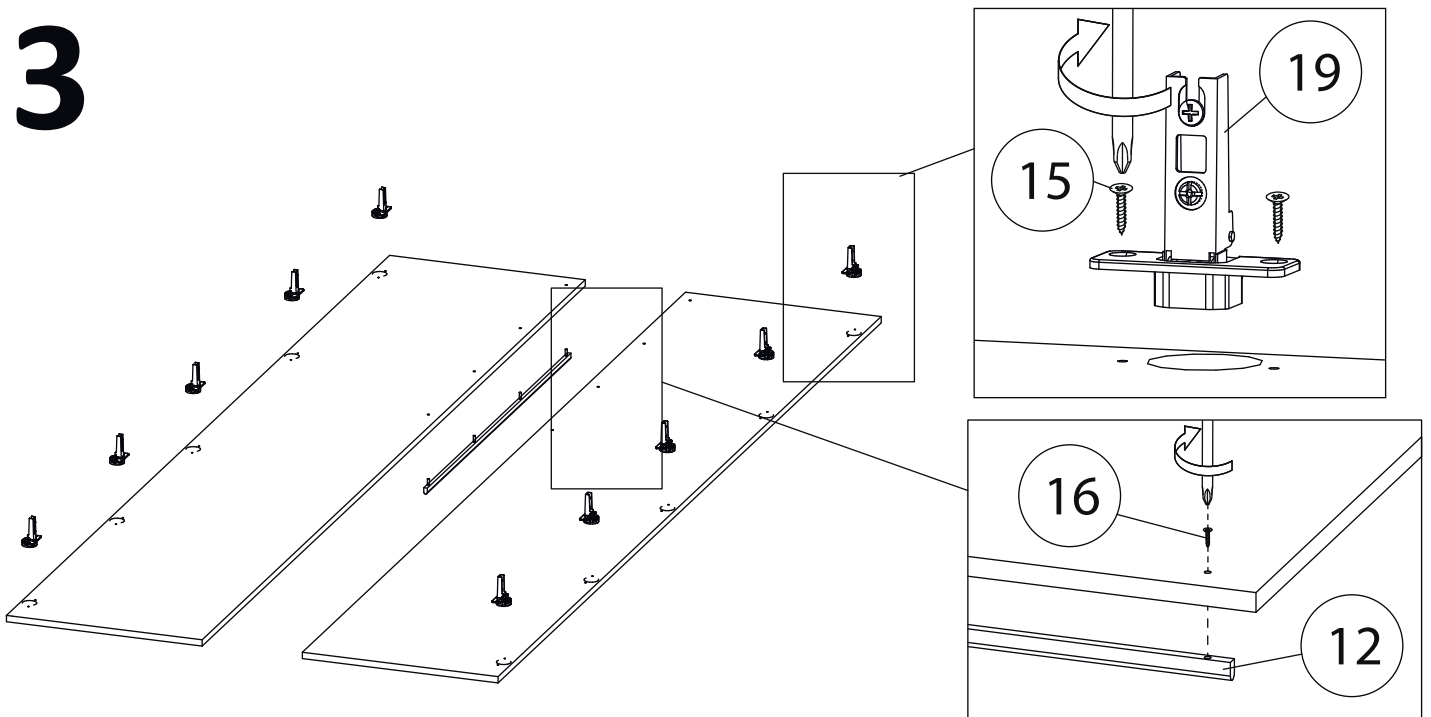

4

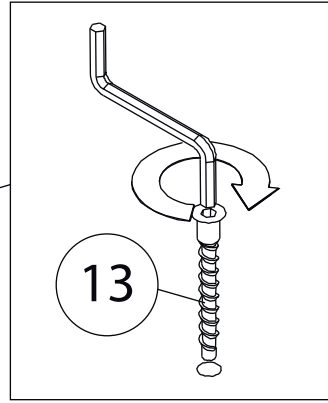
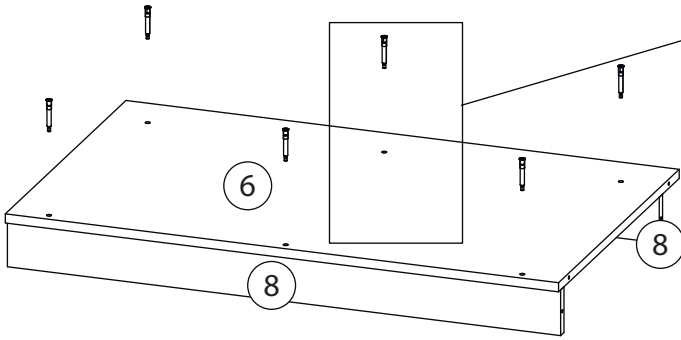

5

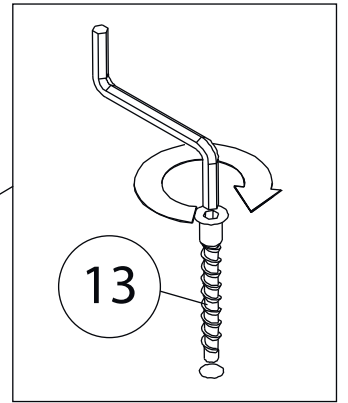
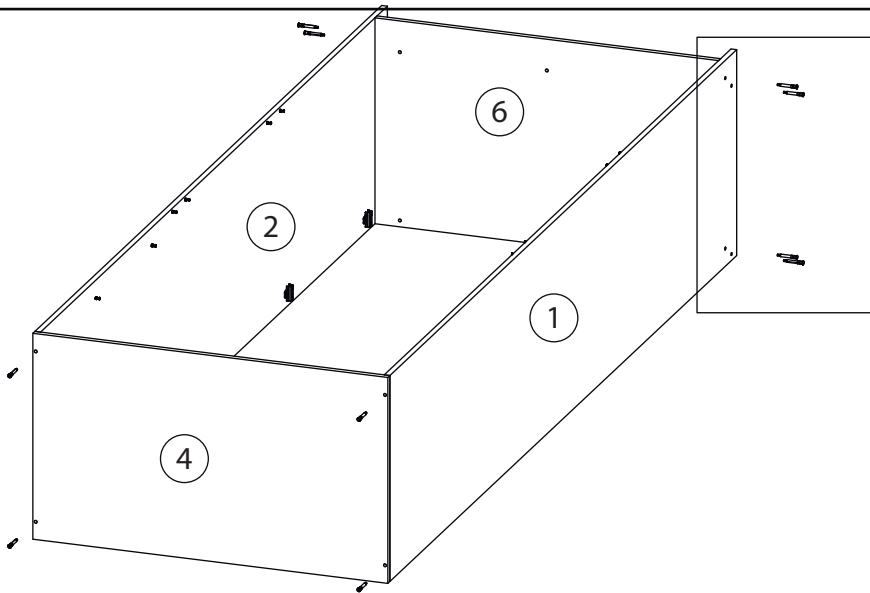

6

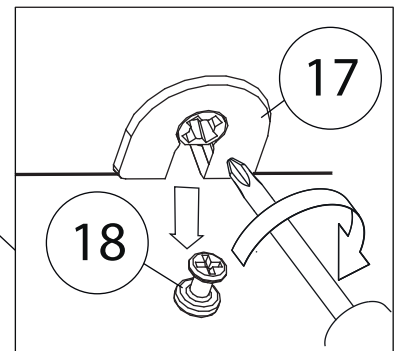
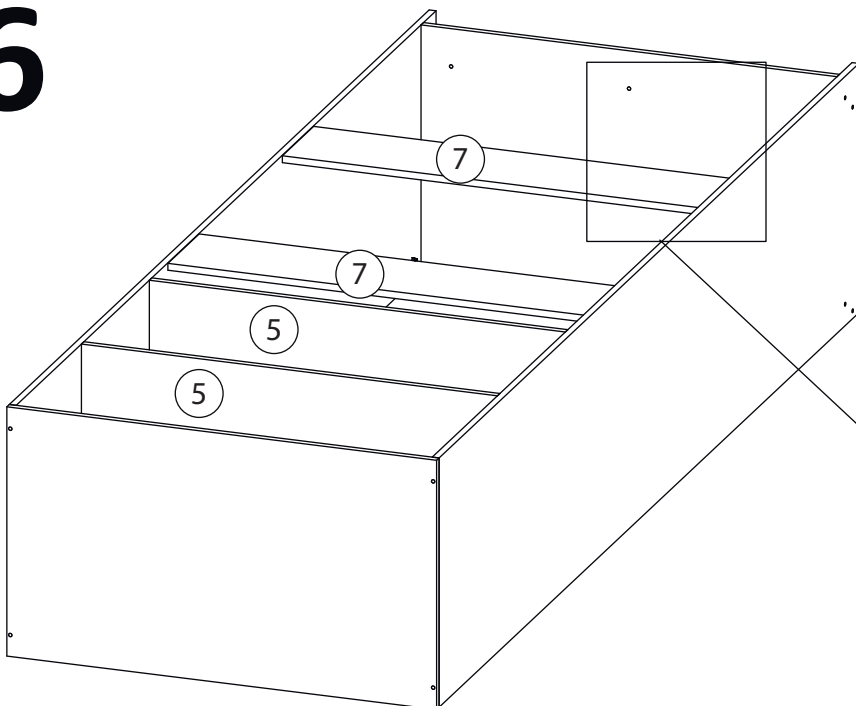

7

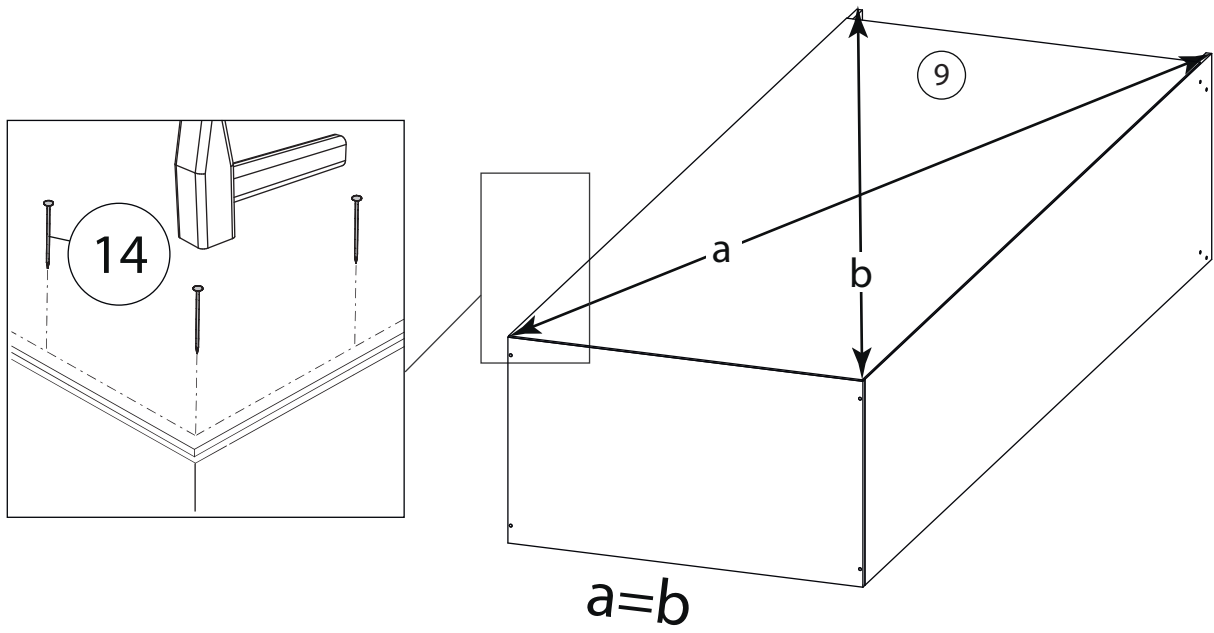

8

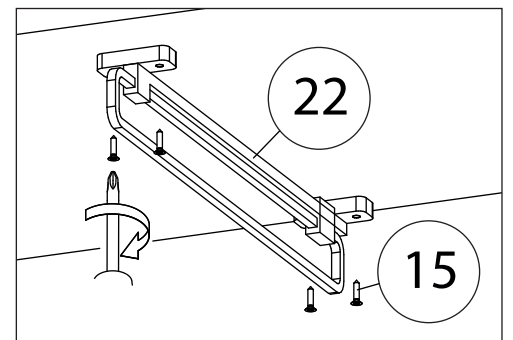
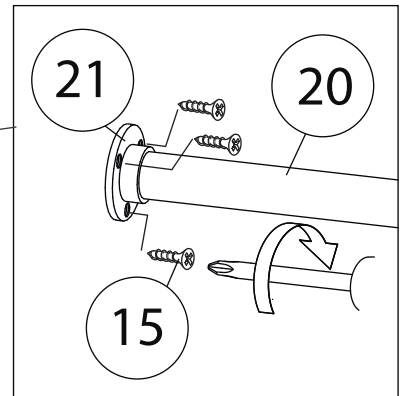
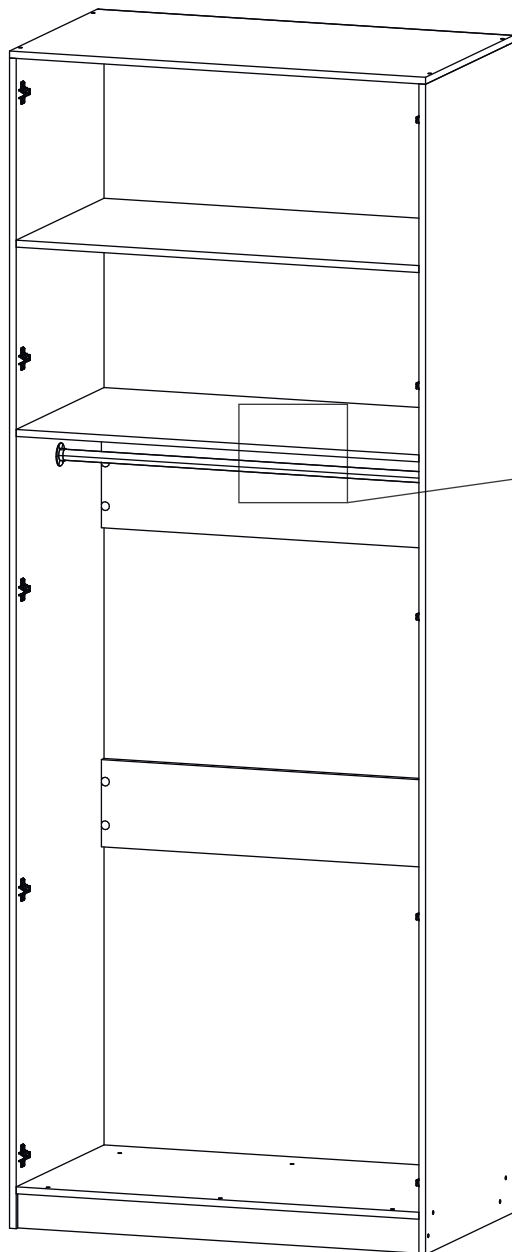

9

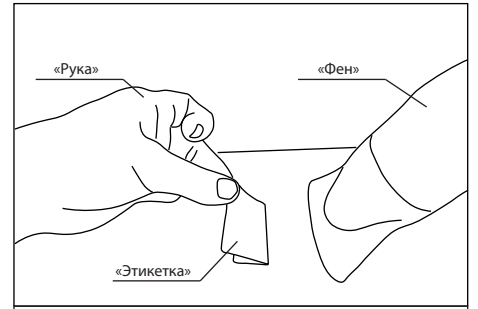
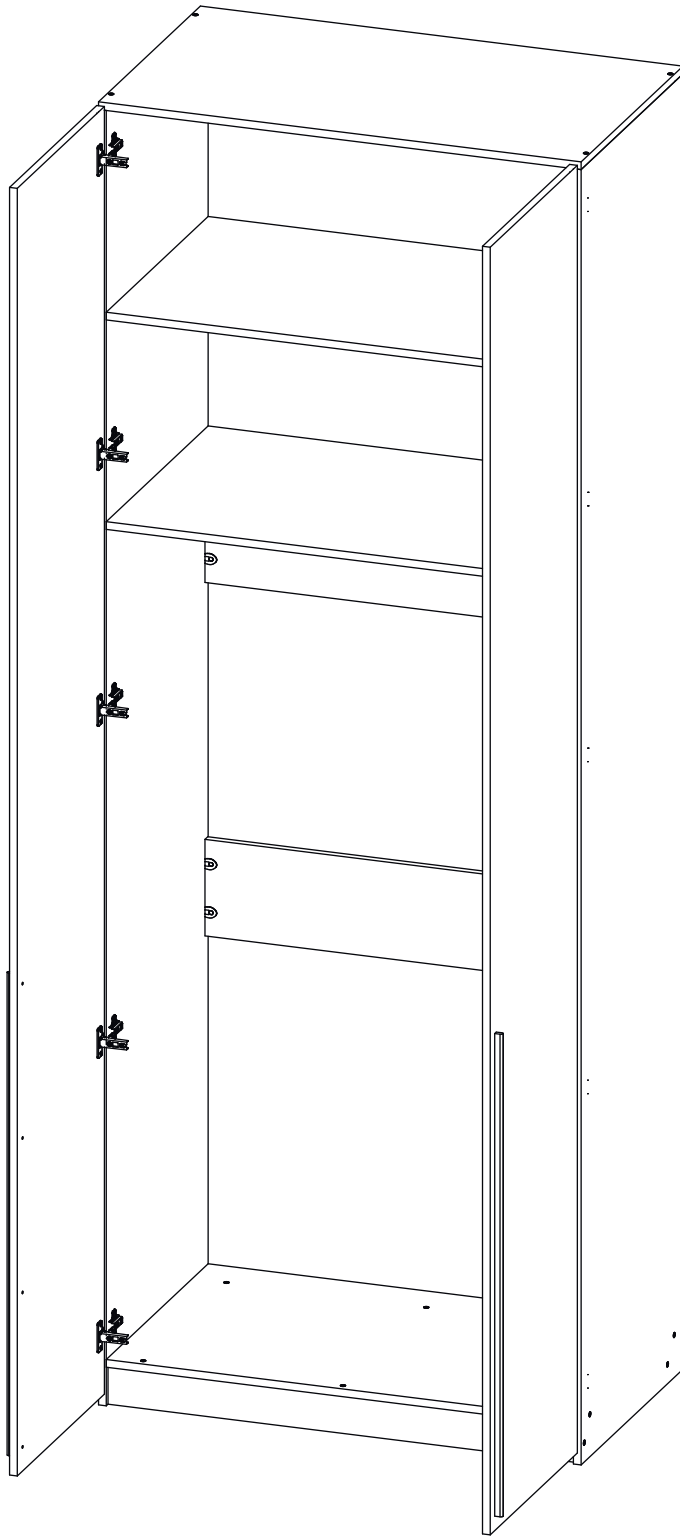

Удалить с детали этикетки со штрихкодом при помощи фена.



Заклеить технические отверстия заглушками.

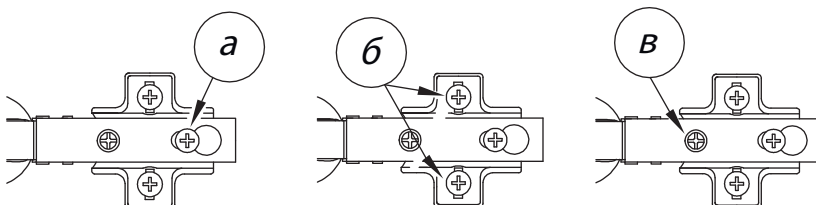

Регулировка петель

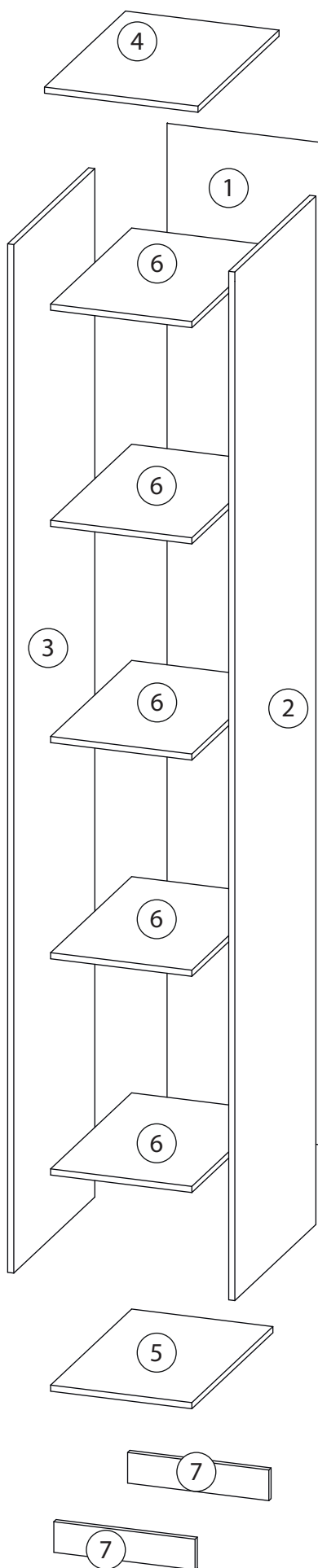

а - регулировка расстояния между дверью и корпусом
б - регулировка положения двери по-вертикали
в - регулировка положения ТТдвери по-горизонтالي

Детали

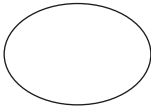
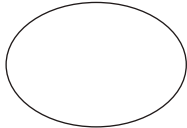
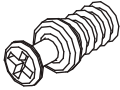
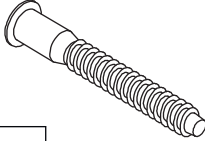
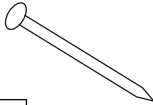

Поз.	Наименование	Кол-во
1	Задняя стенка	1
2	Бок правый	1
3	Бок левый	1
4	Крыша	1
5	Дно	1
6	Полка	5
7	Цоколь	2

Фурнитура

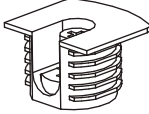
				
8	9	10	11	12
<u>Заглушка</u> <u>Ø13</u>	<u>Заглушка</u> <u>Ø17-20</u>	<u>Винт для стяжки</u> <u>VB35</u>	<u>Евровинт 7x50</u>	<u>Гвоздь 1,6x25</u>
				
13	14			
<u>Саморез 3,5x16</u>	<u>Стяжка VB35</u>			

1

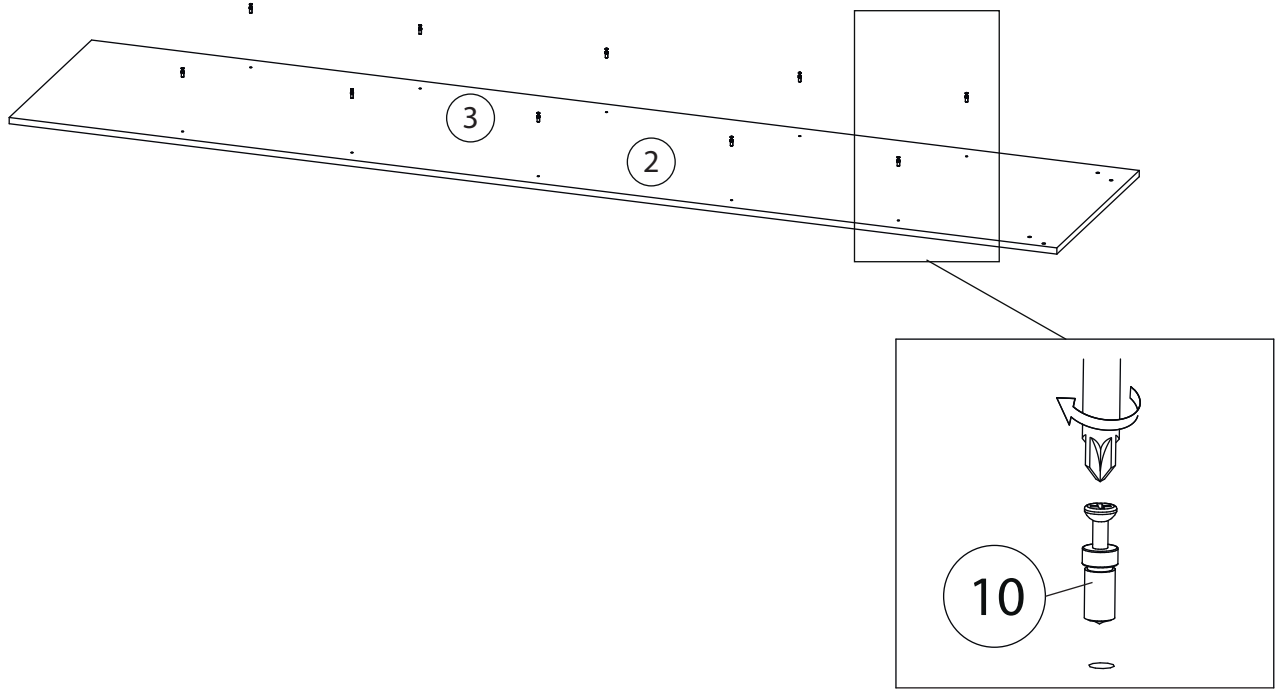

2

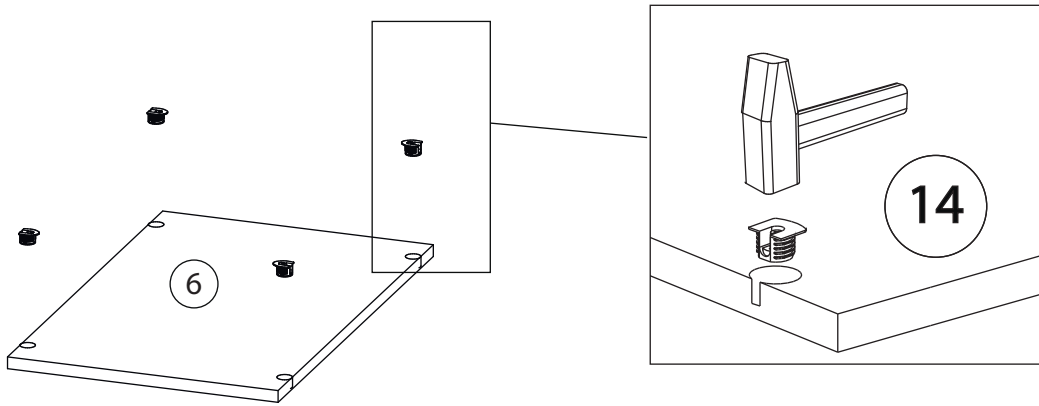

3

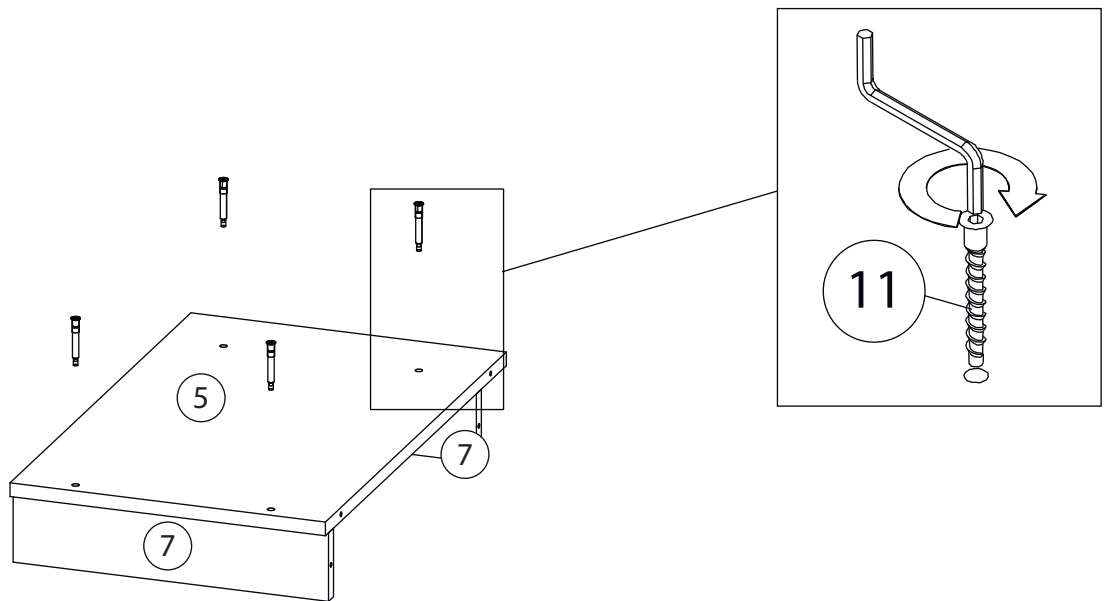

4

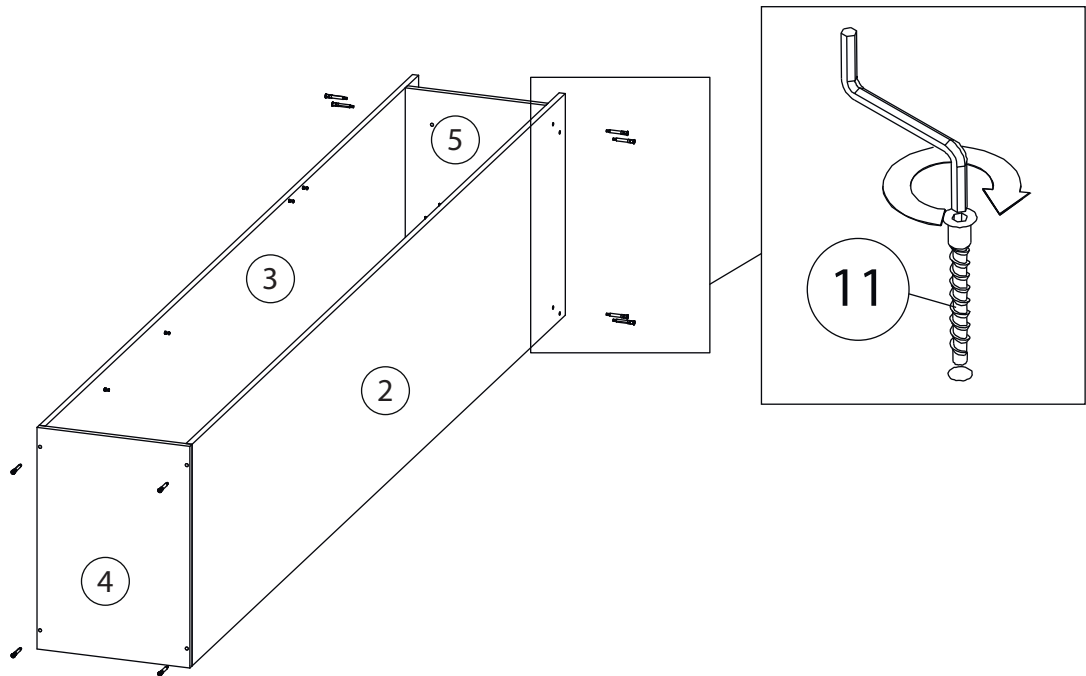

5

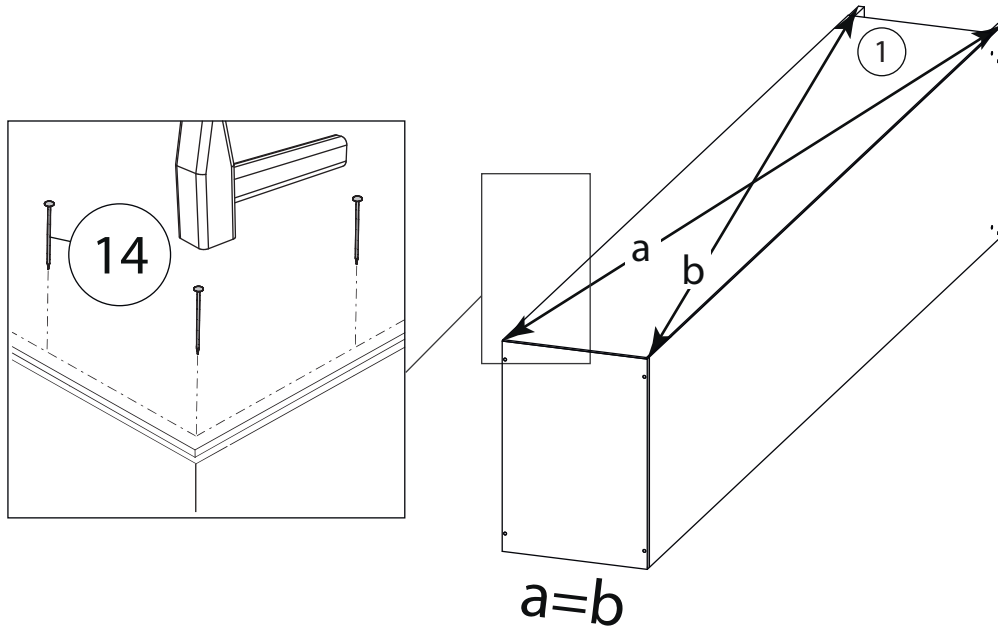

6

